



Installing Protectowire Linear Heat Detector

1. Purpose

The purpose of this guide is to ensure coverage of the area to be protected in accordance with accepted fire protection principles and to assure uniform installations.

Whenever there is a choice between two or more possible procedures, the one which results in increased protection should be followed.

2. Protectowire Linear Heat Detector Selection

The Detector is made in different temperature ratings to allow for variances in normal or ambient temperatures. The Detector may be chosen for specific applications in accordance with the information in the charts shown below.

The description stated for the various models is intended to provide application guidance based upon outer jacket characteristics, and should be used only as a general reference guide. Consult the factory regarding specific applications. All specifications are subject to change without notice.

3. Outdoor Applications

Exposure to direct sunlight may cause the temperature of the Protectowire Linear Heat Detector or its mounting surface to exceed the maximum ambient limit and/or operating temperature rating of the Detector.

Shielding of the Detector may be required in order to reduce the maximum ambient temperature to acceptable limits.

Temperature Ratings and Model Numbers *(Use Linear Detector of Proper Temperature Rating)*

| | Regular 155°F (68.3°C) | Intermediate 190°F (87.8°C) | High 280°F (137.8°C) | Extra High 356°F (180°C) |
|---|---------------------------|--------------------------------|-------------------------|--|
| Alarm Temperature | 155°F (68.3°C) | 190°F (87.8°C) | 280°F (137.8°C) | 356°F (180°C) |
| Max. Installed Ambient Temp. | Up to 100°F (37.8°C) | Up to 150°F (65.6°C) | Up to 200°F (93.3°C) | Up to 221°F (105.0°C) EPR Up to 250°F (121.1°C) |
| Multi-purpose/ Industrial | PHSC-155-EPC | PHSC-190-EPC | PHSC-280-EPC | *PHSC-356-EPC |
| Abrasion/Limited Chemical Resistance | PHSC-155-EPR | PHSC-190-EPR PHSC-190-EPN | PHSC-280-EPR | *PHSC-356-EPR |

MODEL NO. PHSC-6893-TRI Dual Temperature Detector (TRI-Wire™)

Max. Installed Ambient Temp. = 100°F (37.8°C); Low Temp. Pre-alarm = 155°F (68.3°C); High Temp. Alarm = 200°F (93.3°C)

All Protectowire models can be supplied on Messenger Wire. Add suffix “-M” to above model numbers. *FM Approved for special application use only.

Approvals/Maximum Listed Spacing

| Type EPC | Type EPN | Type EPR | Type TRI |
|------------------|------------------|------------------|------------------|
| UL (25 ft./7.6m) | UL (25 ft./7.6m) | UL (25 ft./7.6m) | — |
| FM (25 ft./7.6m) | FM (25 ft./7.6m) | FM (25 ft./7.6m) | FM (15 ft./4.6m) |

The distance between detector runs shall not exceed the listed spacing. Reduced spacing may be required based upon factors such as ceiling height and construction, physical obstructions, air movement, or the authority having jurisdiction (AHJ). When Protectowire is used for sprinkler system activation, special Factory Mutual (FM) reduced spacing guidelines may also be applicable. Consult factory for information on  listed Protectowire.



AN ISO 9001 REGISTERED COMPANY

4. Location and Spacing

Protectowire Linear Heat Detector should be installed as shown in the following diagrams with reference to the corresponding application.

Cable Trays

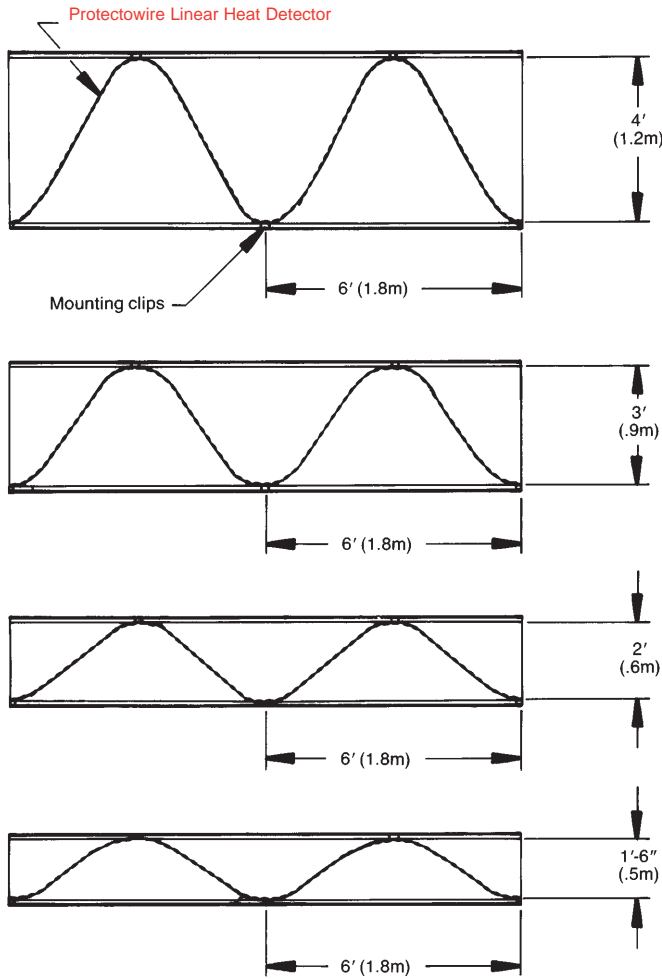

| Estimating chart and formulas | |
|-------------------------------|------------|
| Width of cable tray | Multiplier |
| 4 ft. (1.2m) | 1.75 |
| 3 ft. (.9m) | 1.50 |
| 2 ft. (.6m) | 1.25 |
| 1 ft. 6 in. (.5m) | 1.15 |

Length of cable tray × multiplier = Length of Protectowire
 Length of cable tray ÷ 3 + 1 = Number of mounting clips

Figure 1

Figure 1 illustrates Protectowire Linear Heat Detector installed in a sine wave pattern in a cable tray. The Detector is run on top of all power and control cables in a tray and is spaced as shown in Figure 1. When additional cables are pulled into the tray they should also be placed below the Detector.

*The use of messenger wire is optional; however, when not employed additional fasteners may be required.

Conveyors

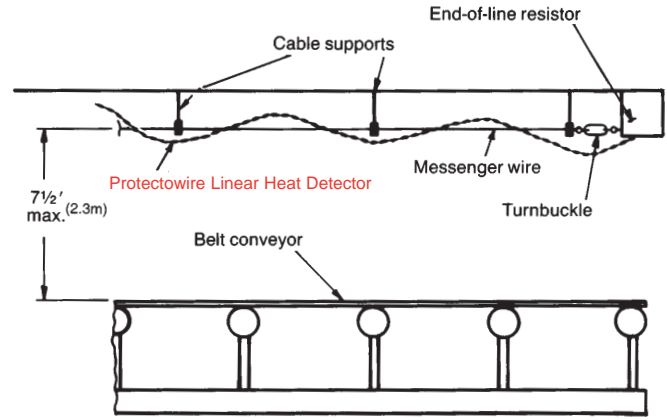

Figure 2

a. Belt type (overhead installation)

Figure 2 illustrates Protectowire Linear Heat Detector with Type M messenger wire installed directly over the conveyor to be protected. Whenever possible, the Detector should be fastened to a covering which is not more than 7.5' (2.3m) above the conveyor belt and which is in a horizontal plane or parallel to the line of the conveyor. This will act as a heat collector and will provide earlier detection. Support is provided by messenger wire* which is fastened with a turnbuckle at a maximum distance of 250' (75.7m). Approved intermediate fastening devices are used at intervals of 15' (4.5m) to 20' (6.0m) to ensure detector tautness.

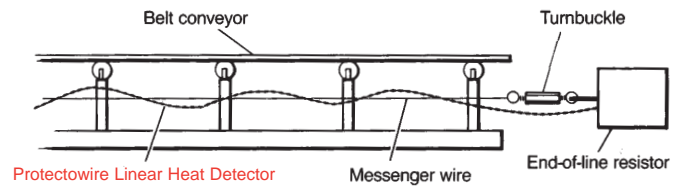

Figure 3A
Side view

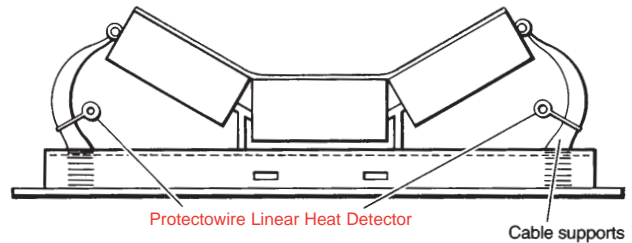

Figure 3B
End view

b. Belt type (idler arm installation)

Figures 3A and 3B illustrates Protectowire Linear Heat Detector with Type M messenger wire installed on either side of the belt in the area between the idler and the roller. Support is provided by messenger wire* which is fastened with a turnbuckle at a maximum distance of 250' (75.7m) to ensure Detector tautness. Approved fastening devices are used at each idler to avoid detector contact with moving parts.

Conveyors (cont.)

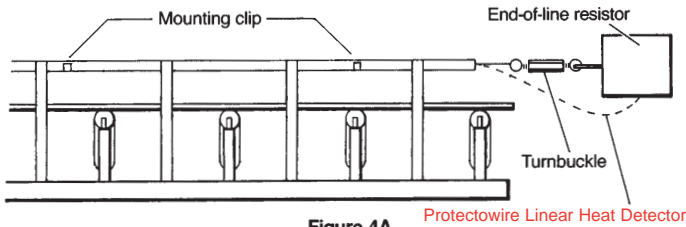

Figure 4A
Side view

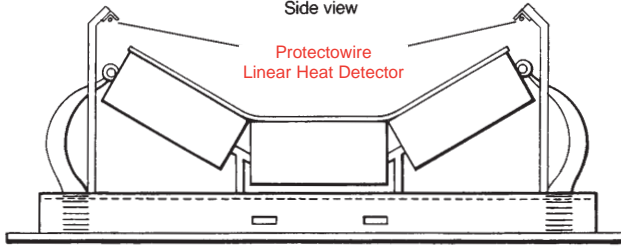

Figure 4B
End view

Belt side installation - see Figures 4A and 4B

(a) A third optional location for installation of Protectowire Linear Heat Detector is beside and slightly above the belt.

(b) Install the Detector with Type M messenger wire* on both sides of the belt beneath a $3\frac{1}{2} \times 3\frac{1}{2} \times \frac{1}{8}$ (7.6cm x 7.6cm x .3cm) angle iron which is used as a heat collector and a support. The angle iron should be located 3 to 4 inches (7.6cm to 10.2cm) above the belt and directly over the line of the outboard roller bearings.

(c) Support the Detector by securing the messenger wire to turnbuckles and eyes located at intervals of up to 250' (75.7m) and also by the use of Protectowire approved fasteners spaced about 15' (4.5m) to 20' (6.0m) apart to limit drooping and avoid contact with moving parts.

(d) An alternate method is to use the Detector without messenger wire and fasten the Detector directly to the angle iron at intervals of 5' (1.5m) to 10' (3.0m) with approved mounting clips.

Power Distribution Apparatus

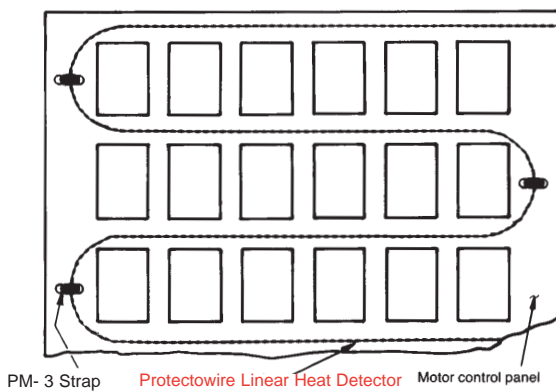

Figure 5

Figure 5 illustrates Protectowire Linear Heat Detector laced through a motor control panel. It is secured with PM-3 wire straps through the apparatus being protected. Other equipment that may be protected in the same manner includes transformers, switchgear, substations, resistor banks, etc. where ambient temperatures do not exceed the Detector's rating.

Dust Collectors/Baghouses

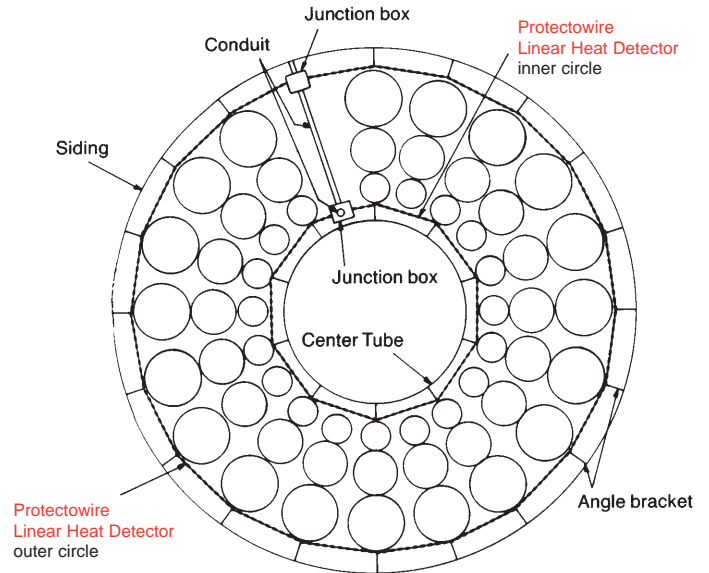

Figure 6A
Base view horizontal section

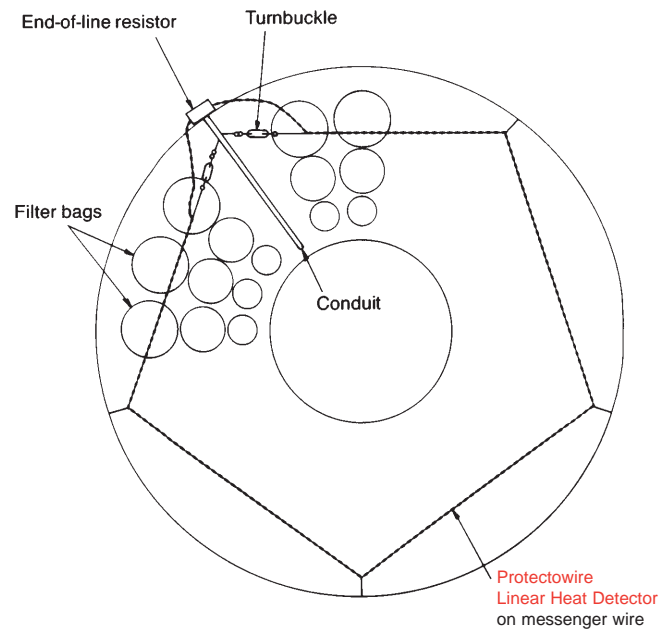

Figure 6B
Top view horizontal section

Figure 6A illustrates Protectowire Linear Heat Detector, supported by angle brackets, installed 30' (.8m) above the inside base of a dust collector.

From the base junction box the Detector is circled around the interior of the outer siding then run in conduit to the center tube where the Detector is circled as shown. The Detector is then run in conduit to the top of the collector where it is supported on messenger wire in the pattern shown in Figure 6B.

The Detector may also be installed around the blower motor frames for early detection of an overheating condition.

Cooling Towers

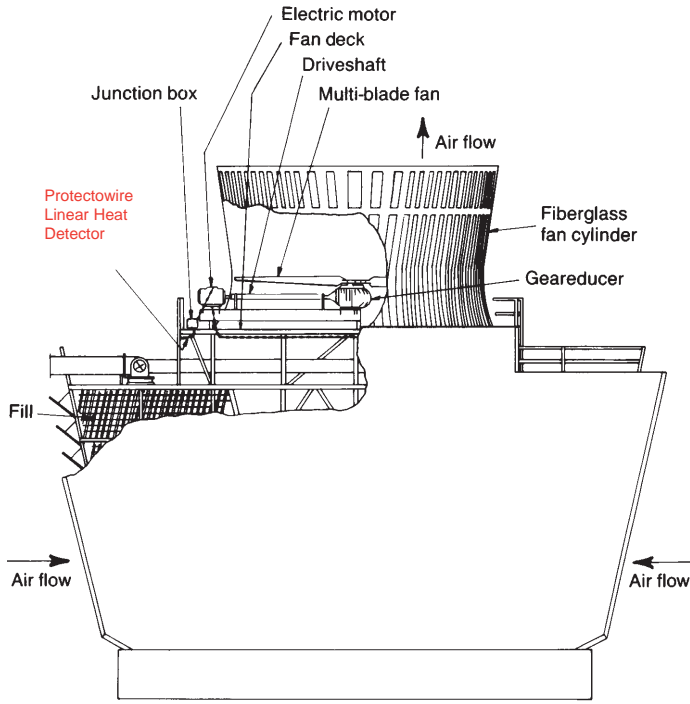

Figure 7
Partial transverse section

Figure 7 illustrates Protectowire Linear Heat Detector installed in a cooling tower. The Detector is run from the junction box mounted on the fan deck flooring, looped over the fan motor, circled around the inside perimeter of the fan cylinder base just beneath the fan deck and returned to the junction box.

Floating Roof Fuel Storage Tank

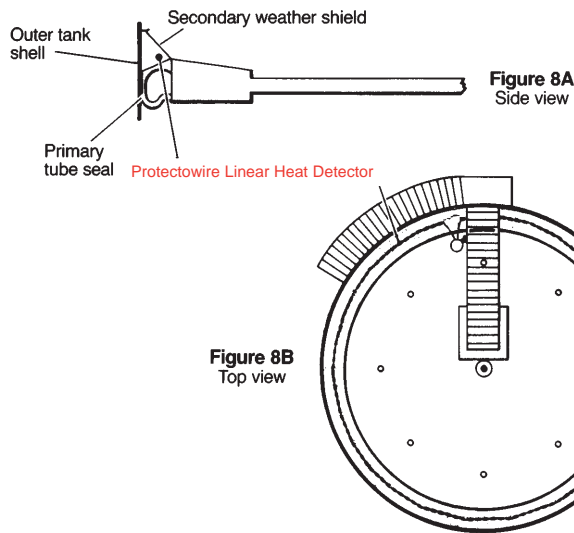

Figure 8B
Top view

Figure 8A and 8B illustrate Protectowire Linear Heat Detector installed around the perimeter of a floating roof fuel storage tank. The Detector is run in the area between the primary tube seal and the secondary weather seal. The need for and type of mounting clips will vary according to type of tank to be protected.

Rack Storage

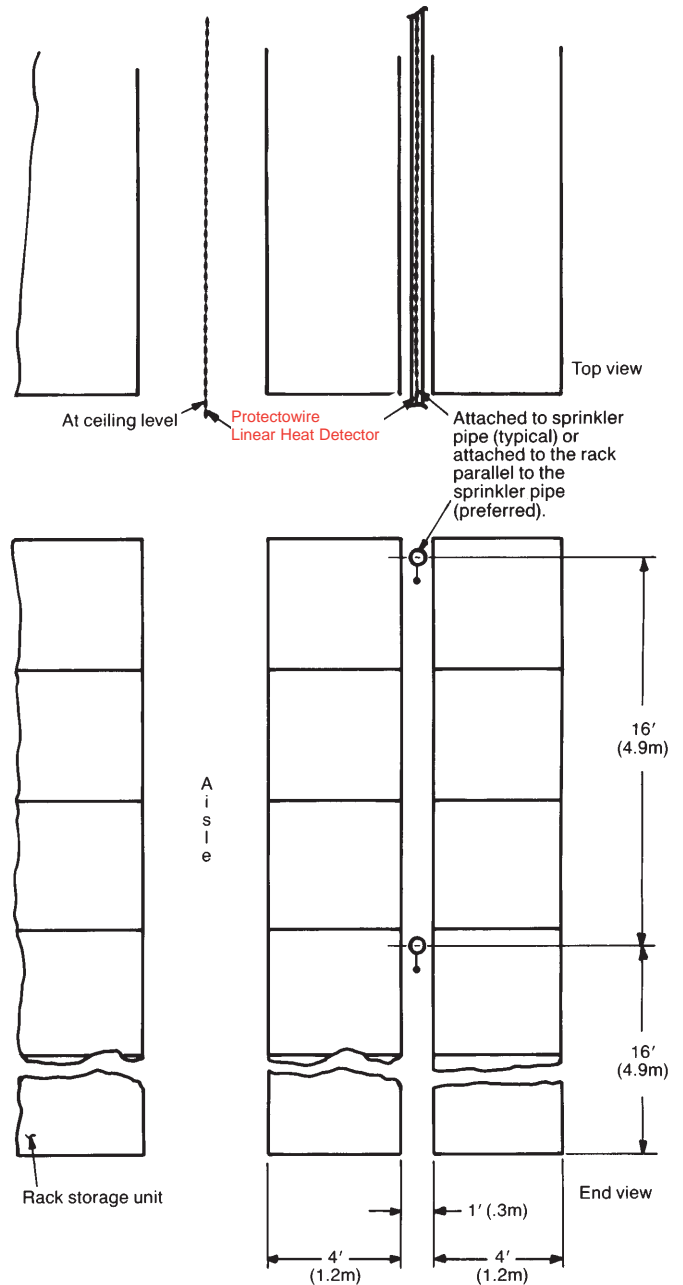

Figure 9

Figure 9 illustrates Protectowire Linear Heat Detector installed in a section of a palletized rack storage area. When used in rack areas protected by sprinklers, the Detector should be installed at each sprinkler level within each rack.

If the racks have no sprinklers and are more than 16' (4.9m) high the Detector should be run at two levels. If the racks are more than 32' (9.8m) high, the Detector should be run at three levels, etc.

5. Circuits

All circuits should be run in series loops. They should not have "T" or "Y" branches and should be terminated in an enclosure which meets the requirements of the specifier. Class A circuits (4 wire) must leave and return to the main control panel, while Class B circuits (2 or 4 wire) may be terminated in a remote end-of-line resistor or in the main panel.

The maximum length of the heat detection circuit is limited by the capacity of the Protectowire control panel, which is usually 2,500 to 3,500 feet (757.6m to 1060.6m) depending on model. Copper wire in metallic tubing may be used to reach the areas to be protected, but only Protectowire Linear Heat Detector should be employed for any part of the circuit which is intended to detect overheat or fire.

There may be parts of a protected area in which the wire in the circuit is not expected to be a detector. Such is the case in locations which have extremely high ambient temperatures or when it is necessary for a circuit to cross another active detection circuit to reach its area to be protected. Under these conditions, copper wire should be installed in these limited sections only and should be spliced to the Detector in suitable enclosures.

6. Fitting and Fastening

All details of installation should be performed in a neat and workmanlike manner. All bending and fitting of Protectowire Linear Heat Detector should be done with the fingers. Pliers or other hard tools should not be used for this purpose. All bends should consist of rounded turns. No 90° bends.

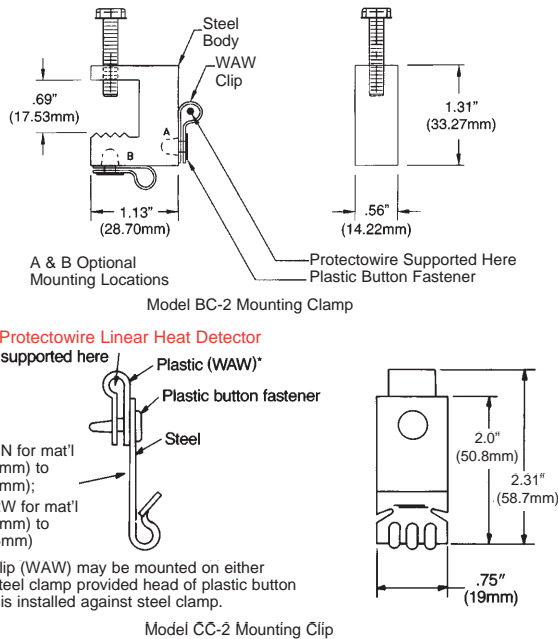

Figure 10A

Figure 10A illustrates fastening devices for cable trays, conveyors, angle irons, I beams, bar joists, etc. PM-3 wire straps (Figure 10C) may be used in covered cable trays with rolled edges and power distribution apparatus such as switchgear, transformers and motor control panels.

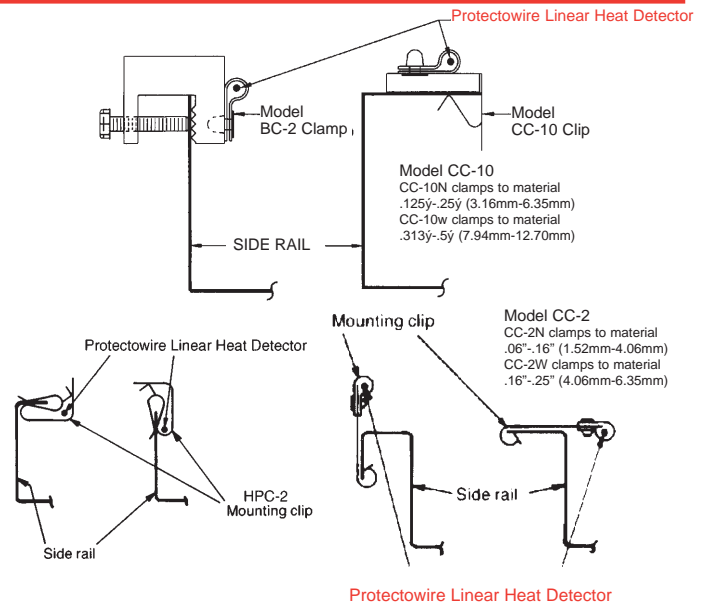

Figure 10B
Typical Cable Tray Mountings

Figure 10B illustrates the application of BC-2, CC-2, CC-10, and HPC-2 mounting clips to various types of cable trays.

Only fastening devices furnished or approved by The Protectowire Company should be used to support the Detector.

7. Mechanical Protection

The Protectowire Linear Heat Detector should be enclosed in conduit wherever it is connected to manual fire alarm stations, test terminals, junction boxes, etc. Open ends of metal conduit through which the Detector passes shall be provided with bushings. After the control panel is mounted and all conduit and wiring installed, the panel doors should be left closed. Both ends of all conduit or wireways which connect to the control should be completely closed off with duct seal so that no gases or condensation will be able to reach the inside of the control cabinet.

Manual stations and end-of-line resistors (not in control panels) should be installed not more than 6' (1.8m) above floor level.

8. Connection and Splicing

All connections to terminals are made by means of soft copper PFL flexible leads furnished by The Protectowire Company, unless equipment is furnished with compression terminals which may be directly connected to Protectowire Linear Heat Detector. Splices should be made in the Detector only by means of PWS splicing sleeves or PWSC splicing connectors furnished by The Protectowire Company. Outdoors applications require the use of SFTS Sealant Tape or appropriately rated junction boxes for in-line splices.

PM-3 Series – Wire Mounting Straps

| Catalog | Pipe size |
|---------|-------------------------------------|
| PM-3A | .75" (19.1 mm) to 2" (50.8 mm) |
| PM-3B | 2.5" (63.5 mm) to 3.5" (88.9 mm) |

(Larger sizes also available)

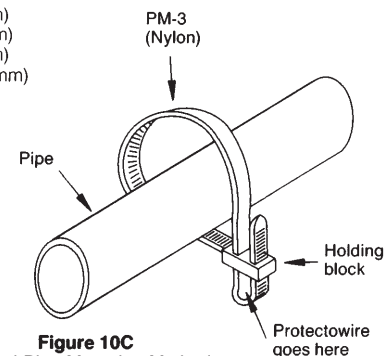
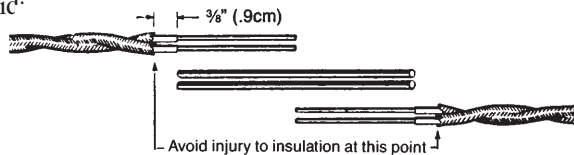

Figure 10C
Typical Pipe Mounting Method

Directions For Use of PWS Splicing Sleeves

1. Remove insulation from each wire to half the length of sleeve, preserving conductor insulation 3/8" (.9cm) from bare wire back to braid.



2. Put sleeve on one pair of wires and with chain nose pliers make an "S" bend in sleeves and wires to secure them to each other:

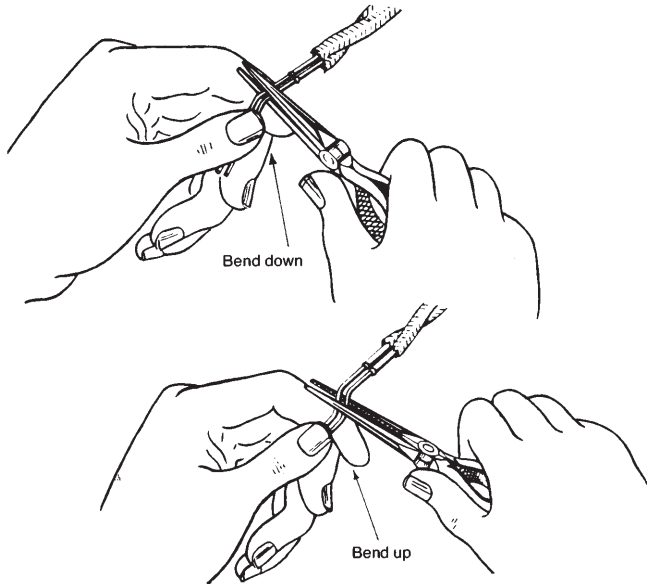

3. Insert other pair of wires in sleeves and make a similar "S" bend. The result should look like this:



4. Double a strip of "Scotch" electrical tape No. 33+ or No. 35 (the adhesive on the other tape may in time soften the heat-sensitive insulation and cause false alarms) to make a non-adhesive insulating pad.

5. Cut this pad just long enough to reach from jacket to jacket of the two cable ends and insert it between conductors:

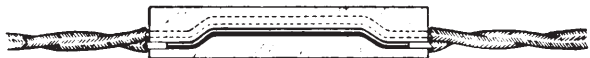

6. Roll insulating pad around the conductors and tape over all to hold insulating pad in place and exclude moisture. The use of SFTS sealant tape is recommended prior to applying the final electrical tape wrap.

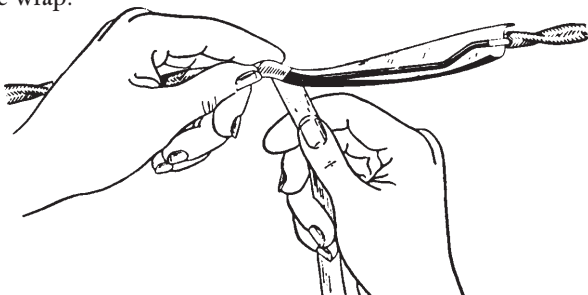

7. Finished splice.



Directions For Use of PWSC Splicing Connectors

1. Remove insulation from each wire leaving 1/2" (1.3cm) of bare Protectowire Linear Heat Detector conductor, preserving 3/8" (.9cm) of insulation from bare wire back to the covering.

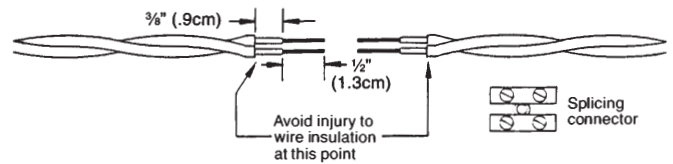

2. Install wires as shown below making sure the entire 1/2" (1.3cm) portion of bare Protectowire Linear Heat Detector conductor is embedded in splicing connector.



3. Secure Protectowire Linear Heat Detector by tightening the connector screws. Plastic screw turrets may be trimmed with snips or utility knife for easier taping.



4. Using 4"-5" (10.1cm-12.7cm) of SFTS tape, starts at least 2" (5.1cm) before connector and wrap the splice. Stretch and overlap each wrap of tape by 1/4-1/2 the width. SFTS tape is recommended specifically for outdoor or high humidity installations.

5. Finish the splice seal by wrapping "Scotch/3M" brand "Super 33+" or "No. 35" electrical tape over the SFTS sealant.

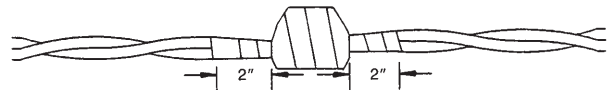

Flexible Leads

Flexible leads are furnished with most Protectowire systems for connecting Protectowire Linear Heat Detector to terminals.



Attach these to the Detector ends, insulate and tape like a splice:



The Protectowire Co., Inc.

Post Office Box 200, Hanover, MA 02339-0200 U.S.A.
781-826-3878, Fax 781-826-2045

Web: <http://www.protectowire.com>

e-mail: pwire@protectowire.com

Special hazard fire detection systems